

SPECIFICATIONS OVERVIEW:

Version	Adjustable - Trim, Trimless
Trim Finish	White, Black
Reflector	Matt Silver, White, Black, Specular
Colour Temperature	3000K, 4000K (others on request)
Beam Angle	20°, 40°, 50°
LED Power	13W, 18W
LED	CRI >90, L80 B10/50,000hr, <3SDCM
Controls	Non-Dim, Phase Dim, 1-10V, DALI
COI	Compliant (4000K only)
IP Rating	IP20
Warranty	5 Years

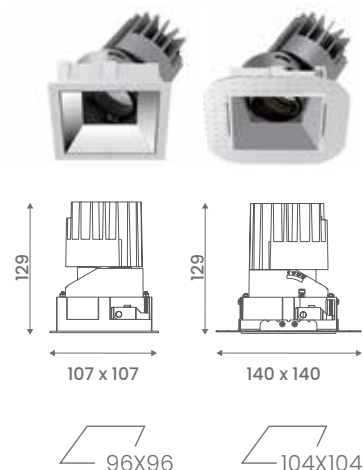

SPECIFICATIONS CODES:

ILDSQ-PRO100A-13W 850-900 lm nominal

CODE	LED Output	Module Output	LED Voltage	LED Current	LED Power	CRI	CCT	BEAM
ILDSQ-PRO100A-13W-930-20	1300lm	850lm	36V	350mA	13W	90	3000K	20°
ILDSQ-PRO100A-13W-940-20	1400lm	900lm	36V	350mA	13W	90	4000K	20°
ILDSQ-PRO100A-13W-930-40	1300lm	850lm	36V	350mA	13W	90	3000K	40°
ILDSQ-PRO100A-13W-940-40	1400lm	900lm	36V	350mA	13W	90	4000K	40°
ILDSQ-PRO100A-13W-930-50	1300lm	850lm	36V	350mA	13W	90	3000K	50°
ILDSQ-PRO100A-13W-940-50	1400lm	900lm	36V	350mA	13W	90	4000K	50°

ILDSQ-PRO100A-18W 1100-1200 lm nominal

CODE	LED Output	Module Output	LED Voltage	LED Current	LED Power	CRI	CCT	BEAM
ILDSQ-PRO100A-18W-930-20	1700lm	1100lm	36V	500mA	18W	90	3000K	20°
ILDSQ-PRO100A-18W-940-20	1800lm	1200lm	36V	500mA	18W	90	4000K	20°
ILDSQ-PRO100A-18W-930-40	1700lm	1100lm	36V	500mA	18W	90	3000K	40°
ILDSQ-PRO100A-18W-940-40	1800lm	1200lm	36V	500mA	18W	90	4000K	40°
ILDSQ-PRO100A-18W-930-50	1700lm	1100lm	36V	500mA	18W	90	3000K	50°
ILDSQ-PRO100A-18W-940-50	1800lm	1200lm	36V	500mA	18W	90	4000K	50°