

SPECIFICATIONS OVERVIEW:

Version	Fixed - Trim, Trimless
Trim Finish	White, Black
Reflector	Matt Silver, White, Black, Specular
Colour Temperature	3000K, 4000K (others on request)
Beam Angle	28°, 35°, 50°
LED Power	13W, 18W
LED	CRI >90, L80 B10/50,000hr, <3SDCM
Controls	Non-Dim, Phase Dim, 1-10V, DALI
COI	Compliant (4000K only)
IP Rating	IP20
Warranty	5 Years

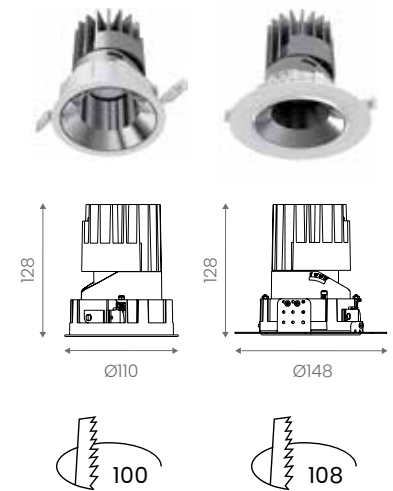

SPECIFICATIONS CODES:

ILD-PRO100F-13W 900-950 lm nominal

CODE	LED Output	Module Output	LED Voltage	LED Current	LED Power	CRI	CCT	BEAM
ILD-PRO100F-13W-930-28	1300lm	900lm	36V	350mA	13W	90	3000K	28°
ILD-PRO100F-13W-940-28	1400lm	950lm	36V	350mA	13W	90	4000K	28°
ILD-PRO100F-13W-930-35	1300lm	900lm	36V	350mA	13W	90	3000K	35°
ILD-PRO100F-13W-940-35	1400lm	950lm	36V	350mA	13W	90	4000K	35°
ILD-PRO100F-13W-930-50	1300lm	900lm	36V	350mA	13W	90	3000K	50°
ILD-PRO100F-13W-940-50	1400lm	950lm	36V	350mA	13W	90	4000K	50°

ILD-PRO100F-18W 1200-1300 lm nominal

CODE	LED Output	Module Output	LED Voltage	LED Current	LED Power	CRI	CCT	BEAM
ILD-PRO100F-18W-930-28	1700lm	1200lm	36V	500mA	18W	90	3000K	28°
ILD-PRO100F-18W-940-28	1800lm	1300lm	36V	500mA	18W	90	4000K	28°
ILD-PRO100F-18W-930-35	1700lm	1200lm	36V	500mA	18W	90	3000K	35°
ILD-PRO100F-18W-940-35	1800lm	1300lm	36V	500mA	18W	90	4000K	35°
ILD-PRO100F-18W-930-50	1700lm	1200lm	36V	500mA	18W	90	3000K	50°
ILD-PRO100F-18W-940-50	1800lm	1300lm	36V	500mA	18W	90	4000K	50°